

BRUCK - ECOJ

*Installation Instructions are applicable for other versions.

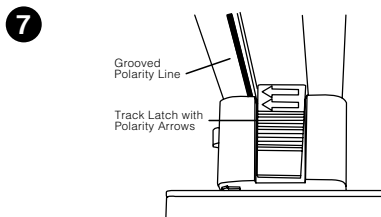
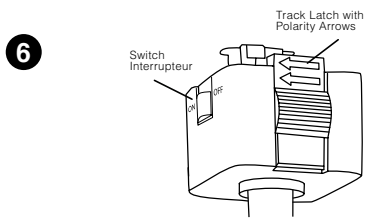
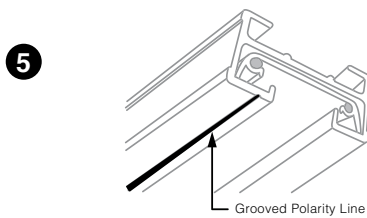
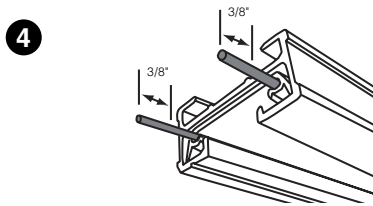
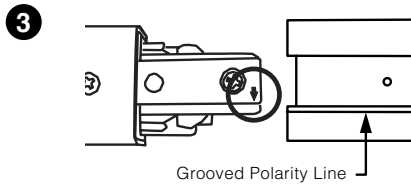
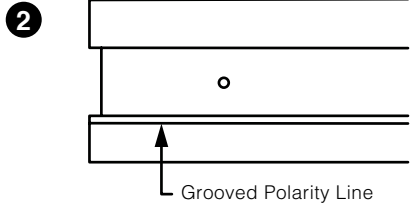
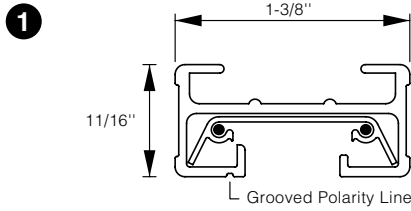

⚠ WARNING ⚠

DANGER - RISK OF SHOCK – DISCONNECT POWER BEFORE INSTALLATION. MAXIMUM AMBIENT TEMPERATURE SHALL BE LESS THAN 50°C. THIS PRODUCT MUST BE INSTALLED IN ACCORDANCE WITH THE APPLICABLE INSTALLATION CODE BY A PERSON FAMILIAR WITH THE CONSTRUCTION AND OPERATION OF THE PRODUCT AND THE HAZARDS INVOLVED.

How to Identify Single-Circuit Track

- Check the identification label inside the track. Single-circuit track will be labeled with one of the following part numbers: ECOJ / 4L, 6L, 8L.
- If you are unable to see the label, measure the height of the track from top to bottom. Single-circuit track will measure 11/16" (See Figure 1).
- The track can also be identified by looking inside the channel. Single-circuit track will have two conductors, one on each side of the channel.
- To secure the track to ceiling, 4', and 6' track sections are supplied with **2 toggle bolts**, 8' track section is supplied with 3 toggle bolts. If suspending the track from the ceiling, **2 supports** are recommended per 4', and 6' track section, **3 supports** per 8' track section.

Single Track Proper Polarity Alignment

Track polarity is indicated by a grooved polarity line that runs the entire length of the track. (Figure 2)

- Track must be joined together maintaining polarity of the entire run. When installing a continuous run of track, do not remove end caps until after the power feed or track connector is inserted in opposite end of track. Place track with end caps against a firm surface, maintaining pressure to keep end cap and internal conductor in place while inserting end feeds or connectors.
- Failure to follow this procedure may result in loss of electrical connection and arcing.
- To wire track connector, for 20A circuits only use **12 AWG** solid copper wire.
 1. Fasten positive/hot (*black*) wire to the positive (*brass*) screw terminal marked **P**.
 2. For two circuit, fasten one positive wire to screw terminal marked **P1** and fasten the second positive wire to screw terminal marked **P2**.
 3. Fasten neutral white wire to the screw terminal marked **N**.
 4. Fasten ground wire to the green ground screw terminal.
 5. Replace track connector cover and secure with screw.
- When installing track end feeds and couplings, the small arrow on the feed or coupling must be inserted into the track pointing at the polarity line. (Figure 3)
- Insert couplings and track feeds fully into track housing maintaining polarity. Tighten set screw at each coupling/feed point.

Single Circuit Track Cutting Instructions

If the track is cut in the field, the following steps must be completed in order for the track to function properly:

- The aluminum track and plastic insulator must **ALL** be the same length.
- After cutting the track to proper length, all copper conductors must be cut back 3/8" from each end to prevent arcing and allow couplings and power feeds to be inserted completely. (Figure 5)
- Follow all other instructions for installing track once the cuts have been completed and ensure to continue to follow polarity.

Read carefully before installing the track systems. Retain these instructions for future reference. Thoroughly inspect the fixture for any freight damage; freight damage should be reported to the delivery carrier. Proper grounding is required for safety.

- Track polarity is indicated by a grooved polarity line that runs the entire length of the track. Fixtures must be installed so that the arrow on the fixture tab points to the polarity line when it is rotated into place.
- All fixtures have indicator arrows designed to point to the track polarity line.
- To install:

- Step 1:** Insert the fixture contacts into the track channel (See Figure 5).
- Step 2:** Retract the track latch by gently pulling down (See Figure 6).
- Step 3:** Rotate the adapter 90° so that the polarity arrow points to the polarity line on the track (See Figure 7).

- When the fixture is installed, the track latch will lock the fixture into the track. **NOTE:** All latches should face the same direction after installation.
- Once the fixture is installed into the track, move the ON/OFF switch to the ON position.

BRUCK - ECOJ

*Installation Instructions are applicable for other versions.

8

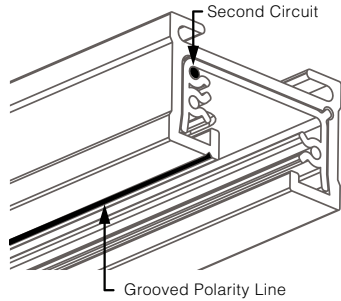

Two-Circuit Fixture Polarity Alignment

- All Ledra fixtures with ECOJ adapters are dual circuit track compatible. Dual circuit tracks contain one neutral and two positive conductors.

• To install:

Step 1: Identify the **POSITIVE** contact on the lighting fixture base, marked **P** (See Figure 9).

Step 2: To access the second circuit, pull up the contact marked **P** to the position shown (See Figure 9). Use needle nose pliers when pulling on contact.

Step 3: Slide the plastic shim (shipped with track) beneath the contact, locking the tabs in place (See Figure 9).

- When the fixture is installed, the track latch will lock the fixture into the track.

NOTE: All latches should face the same direction after installation.

- Once the fixture is installed into the track, move the ON/OFF switch to the ON position.

9

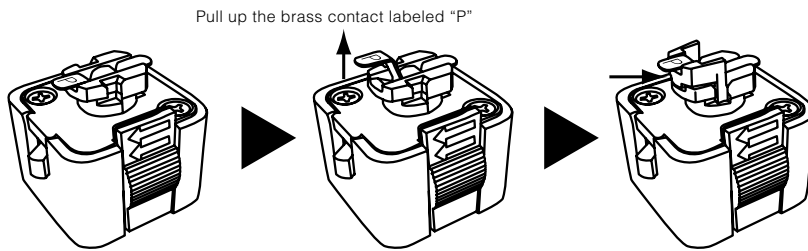

TRACK SYSTEM INSTALLATION - CONNECTORS

1 Coupler Connector

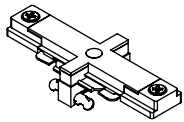

Connects two track sections end to end. Low profile design for a clean continuous run. Cannot be used as feed point.

2 M Feed Connector

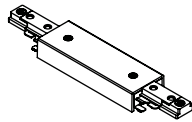

Connects two track sections end to end. May be used as feed point, cover plate is required over junction box.

3 Flexible Connector

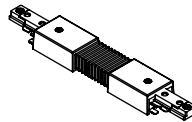

Connects two track sections up to 90° left, right, up or down. Cannot be used as feed point.

4 L Feed Connector

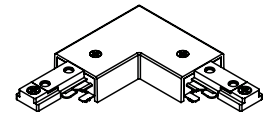

Connects two track sections end to end in a 90° angle configuration. May be used as feed point with cover plate is required over junction box. If opposite polarity is needed unscrew and remove cover, rotate connector legs to desired polarity, place cover back and tighten the screws to secure it. May be used as feed point, cover plate is required over junction box.

5 T Connector

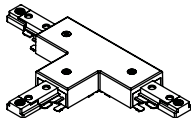

Connects three track sections in a T shape configuration. Reverse polarity available R. May be used as feed point, cover plate is required over junction box.

6 X Connector

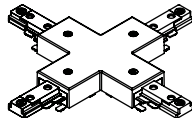

Connects four track sections in an X configuration. Factory wired for two separate 90° runs. May be field wired for one run. May be used as feed point, cover plate is required over junction box.

BRUCK - ECOJ

*Installation Instructions are applicable for other versions.

TRACK SYSTEM INSTALLATION - POWER FEEDS

1 End Feed

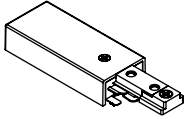

For direct wiring through ceiling with junction box or end feed in suspension, cover plate is required over junction box. Accepts 3/8" or 1/2" (trade size) electrical fittings.

2 Surface Conduit End Feed

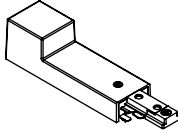

For surface conduit wiring. Accepts 3/8" or 1/2" (trade size) electrical fittings.

3 End Feed Kit with Cover

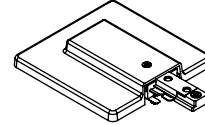

For Wiring through junction box. Built-in junction box cover.

4 Floating Canopy

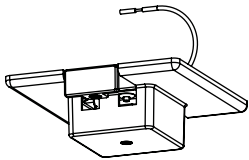

For direct wiring through ceiling with junction box. Can be located anywhere along the track.