

LX SERIES

Spot Monopoint Warm Dim



BK

DESCRIPTION

- LX is a versatile series of performance spec-grade spots and cylinders. LX is rich in technology offering the best-in-class static and dynamic LED components, premium optics and dimming controls. Glare accessories and specialty optics are offered for all variations. Several Mounting options include nine track systems, monopoint spots and pendants, surface mount and conduit j-box cover with knockouts for open ceiling applications. It is offered in a fine detailed matte finish in black and white.

HOUSING

- Casted aluminum housing in textured: black and white.
- Consult factory for custom finishes.

MOUNTING

- Monopoint with field cuttable stem.
- Monopoint to exposed junction box with JCOV mount, field cuttable stem.

LISTING

- CSAus Listed to 1598 (suitable for dry and damp locations)
- cCSA Listed to CSA C22.2 #9.0

LED INFO

- Luminus CDM (or equal) LED: SDCM: 3-step MacAdam Ellipse; Lumen Maintenance: L₇₀ > 54,000 hrs

PROJECT INFORMATION

JOB NAME		TYPE	
ORDERING CODE			

ORDERING CODE

SERIES	LX	
TYPE	35	
LED	WD	warm dim (Luminus)
DELIVERED LUMENS	15LM	1060 lm, CBCP 8,980
	20LM	1620 lm, CBCP 2,550
	Calculated Delivered Lumens = [Delivered Lumen Value] x [CCT Multiplier] x [Reflector Multiplier] Standard Configuration: 3000K 40D lumens, CBCP narrow beam option	
CCT	3018	3000K, dim to 1800K
CRI	97	97 CRI
REFLECTOR	15D ¹	15 degrees (0.97)
	25D ¹	25 degrees (1.00)
	40D	40 degrees (1.00)
	50D	50 degrees (0.94)
	60D	60 degrees (0.99)
	LV ²	LensVector dynamic beam control 15° - 60° (0.80)
VOLTAGE	UNV	120V-277V
DIMMING	CAS	Casambi Bluetooth control with flicker free 1% dimming
	DIM10	0-10V dimming to 1%
	DMXZ	DMX dim to zero
	ELV1 ³	leading & trailing edge (Triac/ELV) dimming to 1%
MOUNTING OPTIONS	MP	monopoint canopy 24" field cuttable to 1"
	JCOV-MP	conduit junction box cover with knockouts, monopoint 24" field cuttable to 1"
FINISH	BK	black
	WH	white
ACCESSORIES	See the last page for details.	

ORDERING CODE

Follow the steps to specify your fixture, example:

LX - 35 - WD - 20LM - 3018 - 97 - 40D - UNV - DIM10 - MP - WH

WD (LED)	POWER
DELIVERED LM	W (97 CRI)
1060	21
1620	27

NOTES

- 15D and 25D only available in 15LM.
- LV available in 15LM with Casambi and DMX dimming only. Length of fixture increases by 1/8".
- ELV/Triac available only in 120V.
- Values shown are for reference only. Actual CCT may vary.

PROJECT INFORMATION

JOB NAME		TYPE	
ORDERING CODE			

MOUNTING OPTIONS

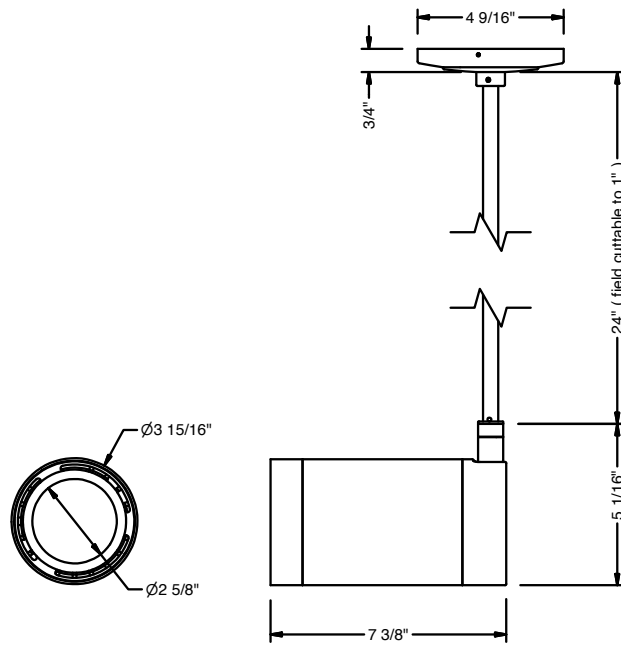

MONOPOINT

PROJECT INFORMATION

JOB NAME		TYPE	
ORDERING CODE			

ACCESSORIES

Accessories Ordering Codes^{1,2,3}

HCL	honeycomb louver (Cat. No. 81331)
BDBK	barndoor, black (Cat. No. K20278)
SNTBK	snoot, black (Cat. No. 81347BK)
SNTWH	snoot, white (Cat. No. 81347WH)
SHNTBK	shroud snoot, black (Cat. No. 81348BK)
SHNTWH	shroud snoot, white (Cat. No. 81348WH)
E	elliptical lens, 30° X 60° (Cat. No 74258)
SBL	smoothing beam lens (Cat. No 74207-SBL)
DL	diffused lens (Cat. No 74207)
BW	batwing lens (Cat. No 74259)

AB	asymmetric beam lens (Cat. No 74261)
HET	high efficiency textured lens, similar to Solite™ (Cat. No. 74262)
GRL	glare reduction lens (Cat. No. 74257)
CF-RD	color filter - red (Cat. No 74272-RD)
CF-BL	color filter - blue (Cat. No 74272-BL)
CF-GR	color filter - green (Cat. No 74272-GR)
CF-AM	color filter - amber (Cat. No 74272-AM)
81464	bezel removal tool

NOTES

1. Complete fixture ordering code by adding accessory ordering code. To order the accessory only use the catalog number.
2. Maximum 2pcs of media per fixture. Standard Configuration includes clear lens, which is replaceable with other media.
3. For best performance pair lenses with 15D and 25D beam options.

LIGHT DISTRIBUTION

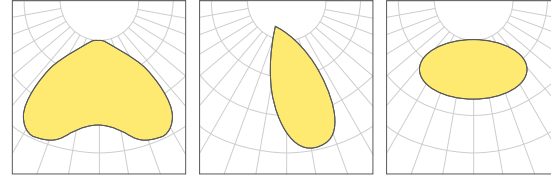

BATWING ASYMMETRIC ELLIPSE 30° X 60°

HONEYCOMB LOUVER



SNOOT

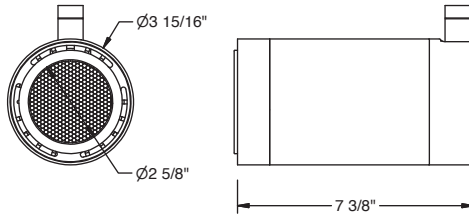

SHROUD SNOOT

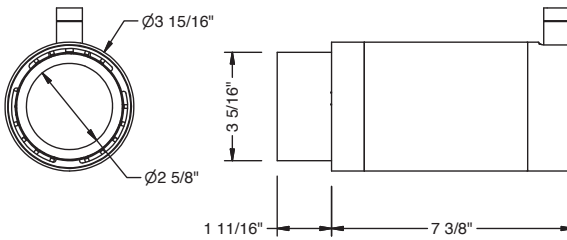

BARNDOOR

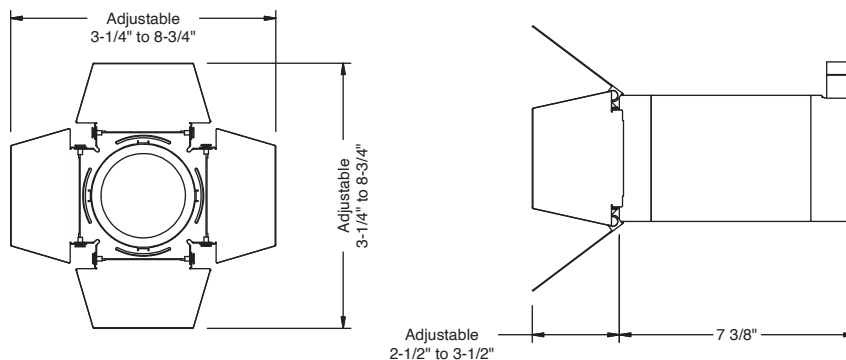
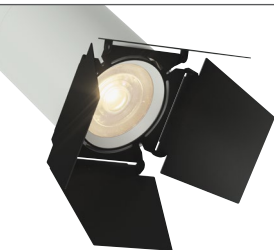
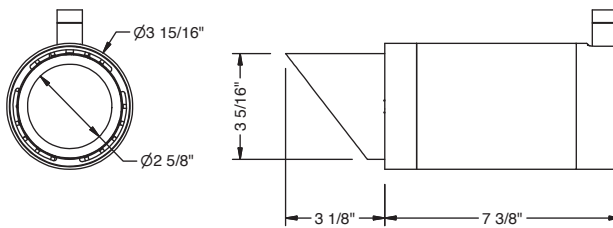

JOB NAME		TYPE	
ORDERING CODE			

HALOGEN DIMMING CURVE

WARM DIM DIMMING CURVE

CCT RANGE: 3000K TO 1800K

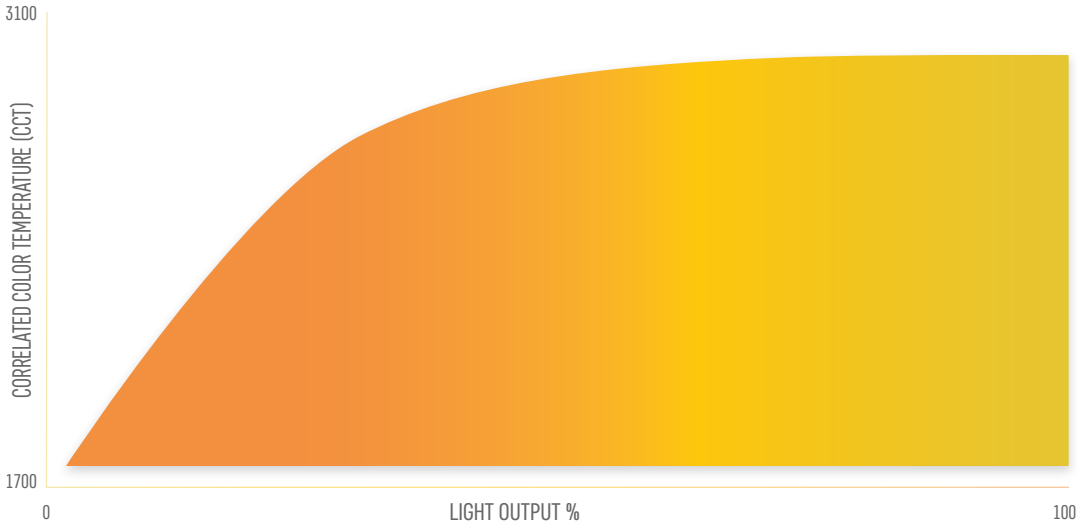

CCT AT LIGHT LEVEL (%LF)⁴

%LF	30LM	25LM	20LM	15LM
100%	3000	3000	3000	3000
50%	3000	3000	3000	3000
25%	2800	2800	2800	2500
10%	2200	2200	2200	2000
5%	1800	1800	1800	1800