

MOTO-ZERO 40

1.5" Motorized Spot Tunable White

formalighting
COLLECTION

LUMINUS CASAMBI



FEATURES*

- Two Motor Drive – 90° Tilt and 350° Rotation.
- 25°, 30° and 40° beam options.
- Motion, CCT control, and dimming controlled by Casambi®.
- Black and white finishes available.

HOUSING

- Casted aluminum housing and integrated driver in adapter with black or white finish.

MOUNTING

- EVO multi-system track by stucchi

ELECTRICAL/CONTROLS

- Full Casambi control: dimming, motion and CCT.

LISTING

- cCSAus Listed to UL1574 (track suitable for dry locations only)

LED INFO

- Luminus tunable white COB:
90 CRI, R9 > 70: SDCM = 3-step MacAdam Ellipse; Lumen Maintenance: L₇₀ > 54,000 hrs

*Fixture is not designed or intended for scene setting. Refer Motolux Pro specification sheet for this type of application requirement.

PROJECT INFORMATION			
JOB NAME		TYPE	
ORDERING CODE			

ORDERING CODE

SERIES	MOTO	motorized track spot
TYPE	MS1	1.5" motorized track spot
LED	TW	tunable white
DELIVERED LUMENS	05LM	490 lm Standard Configuration: 3500K, 25D optic
CCT	2765	2700K to 6500K tunable white
CRI	90	90 CRI
VOLTAGE	48	48V
REFLECTOR	25D 30D 40D	25 degrees ^{25°} , CBCP 1,500 30 degrees ^{30°} , CBCP 1,300 40 degrees ^{40°} , CBCP 930
DIMMING	CAS ¹	Casambi Bluetooth control with flicker free 1% dimming
FINISH	BK WH	black white
MOUNTING OPTIONS	MEVO	stucchi multi-system track
ACCESSORIES	See the last page for details.	

ORDERING CODE

Follow the steps to specify your fixture, example:

MOTO - MS1 - TW - 05LM - 2765 - 90 - 48 - 25D - CAS - WH - MEVO

SW (LED)	POWER
DELIVERED LM	W (80 CRI)
490	8

NOTES

1. Motion, dimming and CCT control by Casambi.

JOB NAME		TYPE	
ORDERING CODE			

PHOTOMETRIC DATA

NO ACCESSORY

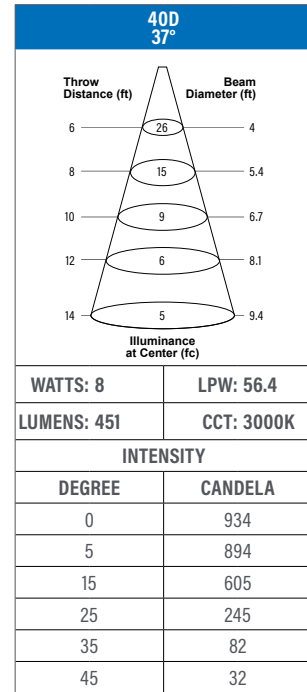
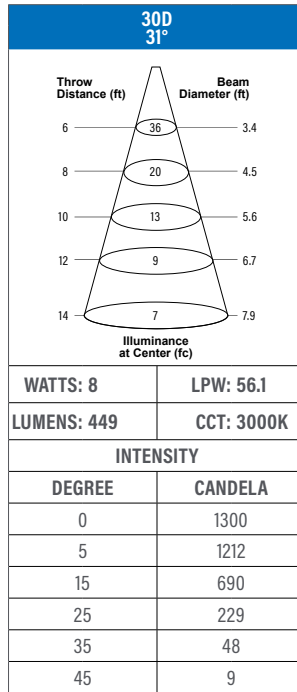
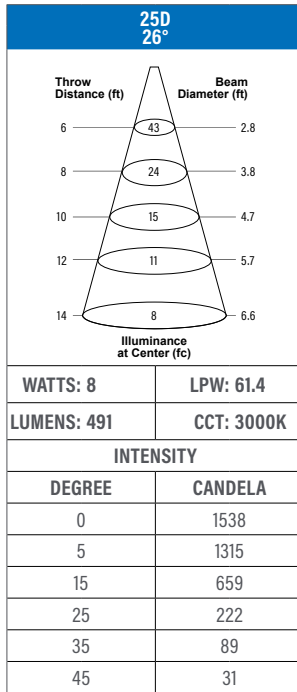

HCL

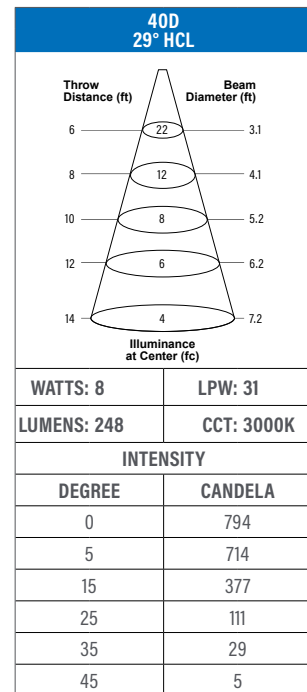
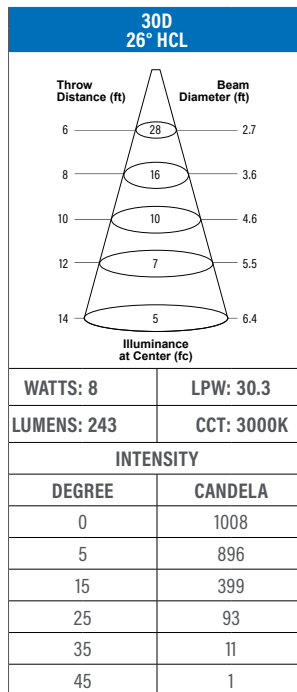
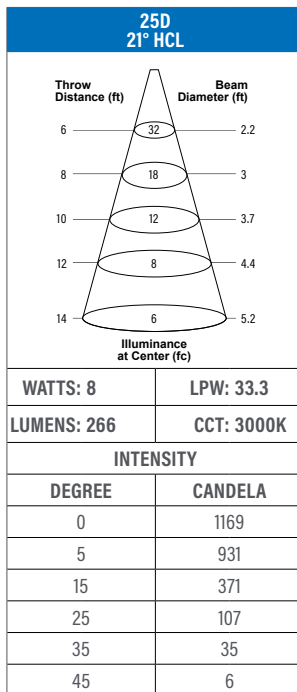

PROJECT INFORMATION

JOB NAME		TYPE	
ORDERING CODE			

PRODUCT DIMENSIONS

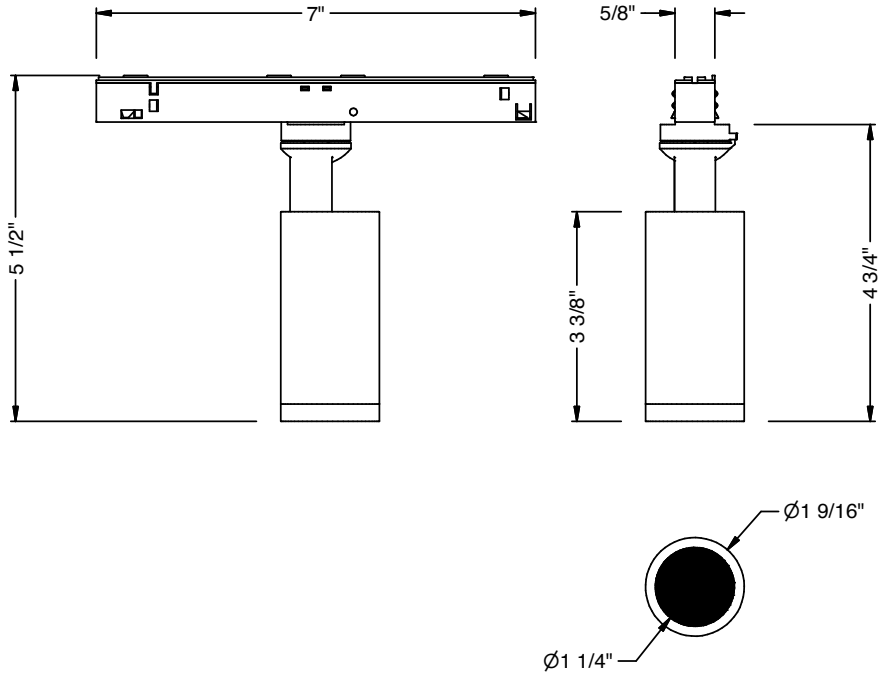

ACCESSORIES

Accessories Ordering Codes¹
 HCL honeycomb louver (Cat. No. MOTO-MS1-SW-48-HCL)

NOTES
 1. Complete fixture ordering code by adding accessory ordering code.
 To order the accessory only use the catalog number.

HONEYCOMB LOUVER

