

RENATA

Canopy, Track SW WD E26

WEPLIGHT
COLLECTION



DESCRIPTION

WEP Light (Wood Ecological Project) is designed, handcrafted in Argentina and assembled in the USA. A two-sided wood veneer section is fused with a malleable center panel for strength and flexibility to create a work of art in a variety of styles and sizes. A plethora of colors for interior and exterior of the shade are offered. Acoustic WEP lights are offered in multiple shapes and sizes and are NRC rated by a third-party lab for absorption efficiency. The natural recycled wood in many finish options, is complimented by a natural Argentinian lamb's wool inner shade for superior absorption. Factory assembly for most shades. Due to hand-crafted nature, colors vary from fixture to fixture and from photo.

HOUSING

- Sustainable, recycled, reconstructed wood veneer
- Factory assembled shades with some exceptions due to size

MOUNTING

- Bayonet with 108" cord, field adjustable
- Optional track mounting options: Global Trac Systems, GEO track, ECO track / HALO® track, and Zonyx track.
- Renata 30: 2.42 lbs.
- Renata 30G: 14.77 lbs.
- Renata 32: 3.3 lbs.
- Renata 56: 5.4 lbs.
- Renata 80: 8.37 lbs.
- Renata 98: 10.47 lbs.
- Renata 116: 17.63 lbs.

LISTINGS

- ULus listed to UL1598 (suitable for indoor use and dry locations only)
- cUL listed to CSA C22.2 #250.0

CCT AT LIGHT LEVEL (%LF) FOR WARM DIM LED

%LF	CCT
100%	3000
50%	2800
25%	2300
10%	1900
5%	1800

PROJECT INFORMATION			
JOB NAME		TYPE	
ORDERING CODE			

ORDERING CODE

SERIES	WEP	wood shade
TYPE	REN	renata
SIZE	30 30G ^{1,2} 32 56 80 ¹ 98 ¹ 116 ¹	30 pendant, 1 x light source 30 group pendant, 7 x light source 32 pendant, 1 x light source 56 pendant, 1 x light source 80 pendant, 1 x light source 98 pendant, 3 x light source 116 pendant, 3 x light source
LIGHT SOURCE	LE26 ³ LLED	E26 socket LED, 1000 lm
CCT	30K 35K 3018	3000K, standard white LED 3500K, standard white LED 3000K, dim to 1800K, warm dim LED <small>Not applicable to LE26 option. Do not include in LE26 ordering code.</small>
CRI	90 ⁴ 95 ⁵	90 CRI, standard white 95 CRI, warm dim <small>Not applicable to LE26 option. Do not include in LE26 ordering code.</small>
MOUNTING OPTION	PBK PMC PWH ECOHBK ECOHMC ECOHWB ECOJBK ⁶ ECOJMC ⁶ ECOJWH ⁶ GEOBK GEOHC GEOHW ZONMC	canopy, black with black cable canopy, matte chrome with black cable canopy, white with white cable ECO/HALO black with black cable ECO/HALO matte chrome with black cable ECO/HALO white with white cable JUNO black with black cable JUNO matte chrome with black cable JUNO white with white cable GEO black with black cable GEO matte chrome with black cable GEO white with white cable Zonyx matte chrome with black cable
OUTER SHADE COLOR	ASH BCH BLU EBY GRN GYO OCH PGR PTB RED ROS TRC WHT WNG YLW LPT VLT	ash beech blue ebony green grey oak ocher pale green petiribi red rose terracotta white wenge yellow light petrol violet
INNER SHADE COLOR	ASH BCH BLU EBY GRN GYO OCH PGR PTB RED ROS TRC WHT WNG YLW LPT VLT	ash beech blue ebony green grey oak ocher pale green petiribi red rose terracotta white wenge yellow light petrol violet

ORDERING CODE

Follow the steps to specify your fixture, example:
WEP - REN - 56 - LLED - 30K - 90 - ECOHBK - PTB - ASH

NOTES

- 30G, 80, 98 & 116 available in PBK and PWH mounting only.
- 30G available in LE26 light source only.
- 15W E26 socket available, use base option code LE26-15.
- 90 CRI for standard white only.
- 95 CRI for warm dimming only.
- Not available with LLED.

COLOR OPTIONS



PROJECT INFORMATION

JOB NAME		TYPE	
ORDERING CODE			

LIGHT SOURCE

Light Source	LLED - Static White LED	LLED - Warm Dim LED	LE26 - E26 Socket
Performance			
LED	Cree CMT 1420	Luminus CDM-9	Lamp Dependant
Lumens	1150 lm	850 lm	
CCT	3000K or 3500K	3000K to 1800K	
SDCM	2-Step MacAdam Ellipse	3-Step MacAdam Ellipse	
CRI	>90	>95	
Lumen Maintenance	L ₉₀ > 41,500 hours	L ₇₀ > 54,000 hours	
Technical Specs			
Socket Listing	Integrated LED module ETLus Listed to UL1598, and UL1574 (Suitable for dry locations only) cETL Listed to CSA C22.2 #250.0 and #9.0	Integrated LED module ETLus Listed to UL1598, and UL1574 (Suitable for dry locations only) cETL Listed to CSA C22.2 #250.0 and #9.0	Medium E26 base socket ETLus Listed to UL1598, and UL1574 (Suitable for dry locations only) cETL Listed to CSA C22.2 #250.0 and #9.0
Mounting			
Canopy	120-277Vac, 50/60Hz input 14.3W, 14.9VA Tri-mode dimming (Triac, ELV and 0-10V)	120-277Vac, 50/60Hz input 15.6W, 16.1VA Tri-mode dimming (Triac, ELV and 0-10V)	120Vac input 100W, 100VA (max 100W lamp) Dimmable (with compatible lamp)
Line Voltage Track	120Vac, 50/60Hz input 14.3W, 14.9VA Triac and ELV phase dimming Connects to line voltage adapter (ECOH, GEO, Zonyx)	120Vac, 50/60Hz input 15.6W, 16.1VA Triac and ELV phase dimming Connects to line voltage adapter (ECOH, GEO, Zonyx)	120Vac input 100W, 100VA (max 100W lamp) Dimmable (with compatible lamp) Connects to line voltage adapter (ECOH, ECOJ, GEO, Zonyx)
Warranty			
	5 year limited fixture warranty	5 year limited fixture warranty	1 year limited fixture warranty

PROJECT INFORMATION

JOB NAME		TYPE	
ORDERING CODE			

MOUNTING OPTIONS

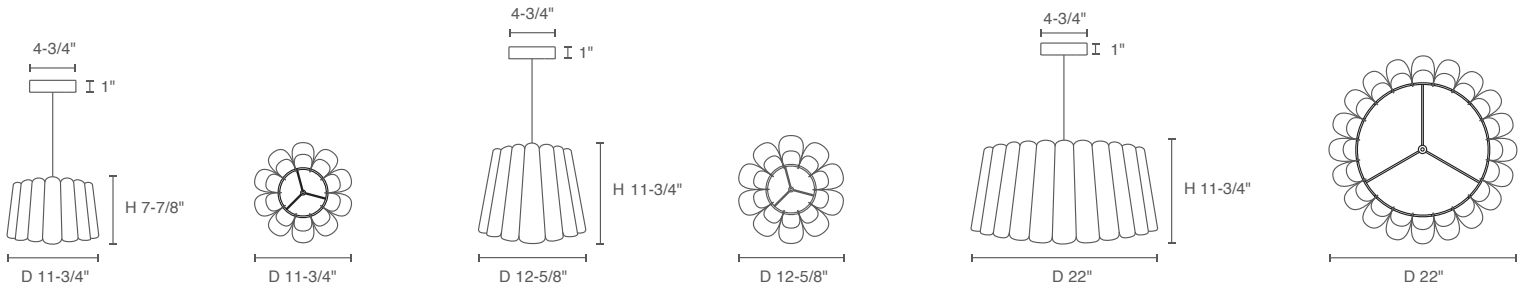

RENATA 30

RENATA 32

RENATA 56

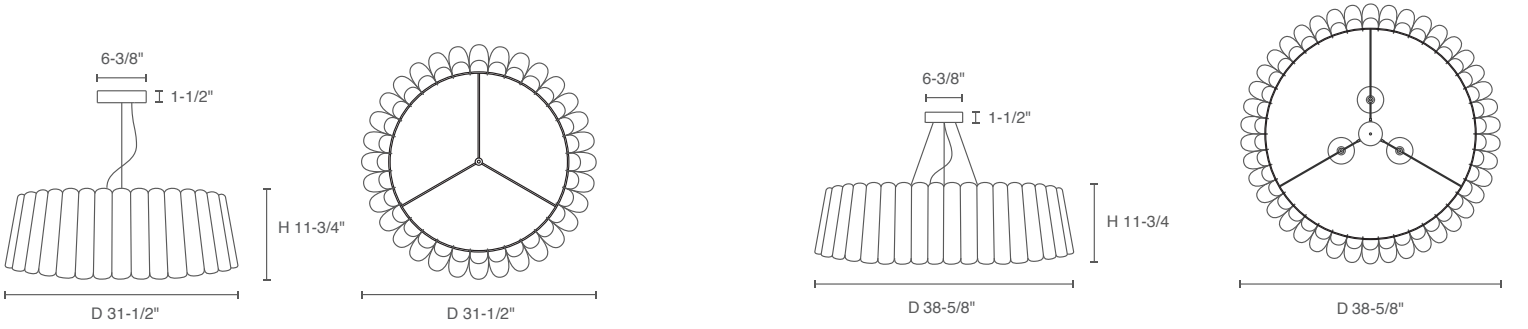

RENATA 80

RENATA 98

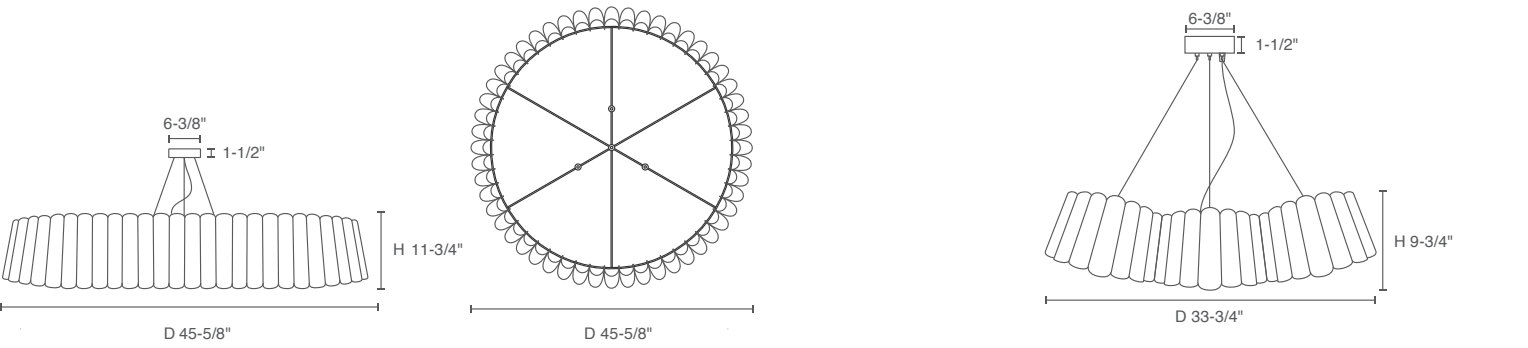

RENATA 116

RENATA 30G

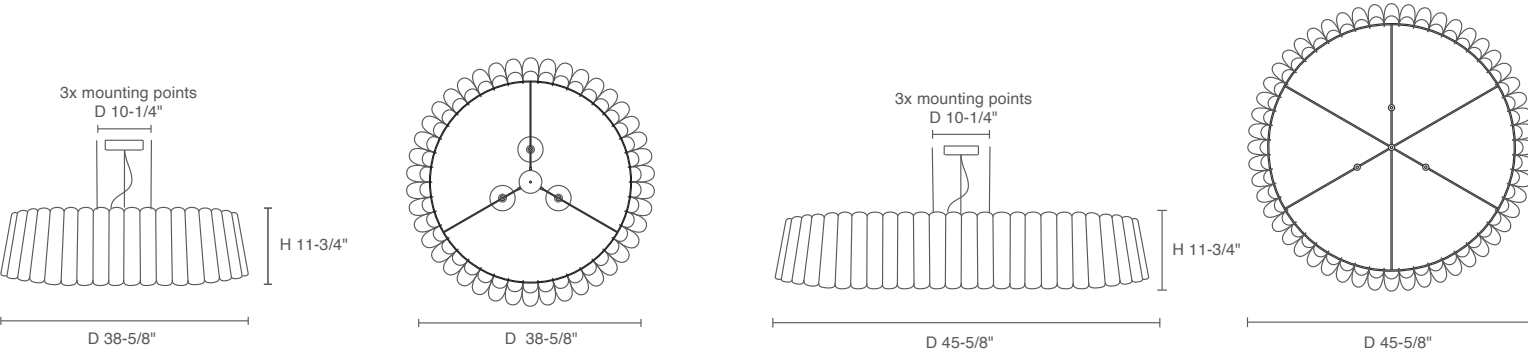

RENATA 98 LLED

RENATA 116 LLED

PROJECT INFORMATION

JOB NAME		TYPE	
ORDERING CODE			

MOUNTING OPTIONS

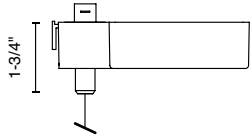

LLED-ECOH

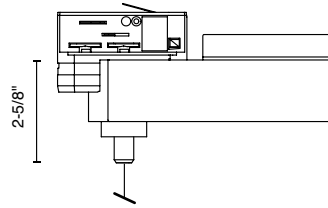

LLED-GEO

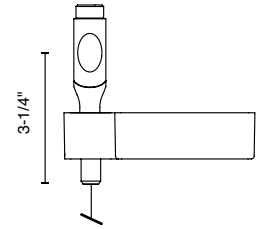

LLED-ZONMC

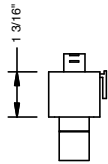

LE26-ECOH/ECOJ

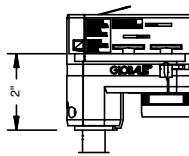

LE26-GEO

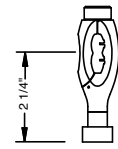

LE26-ZONYX